

Thank You for choosing ARI AKON™

ARI AKON™
2794 LOKER AVE WEST
SUITE 107
CARLSBAD CA 92008

1-877-4-ARIAKON
760-268-0735
FAX 760-268-0736

On the web
WWW.ARI AKON.COM

ARI AKON™ All Rights Reserved.
ARI AKON™, SIM™, SIM-4™, SIM-5™, SIM-5N, SIM-15™,
and TORO™ are trademarks of ARI AKON LLC.
Any use or reproduction of materials, images, names, or logos
found in this manual is strictly prohibited.



ARE YOU A PLAYER?
SIM-5 and SIM-5N
SERIES
.68 CALIBER PAINTBALL MARKER



OWNER'S MANUAL
READ AND UNDERSTAND ALL
INSTRUCTIONS AND
WARNINGS IN THIS MANUAL BEFORE
USING THIS PAINTBALL MARKER.

WARNING

THIS PAINTBALL MARKER IS NOT A TOY. MISUSE WILL CAUSE SERIOUS INJURY OR DEATH. PROPER EYE AND HEAD PROTECTION SPECIFICALLY DESIGNED FOR PAINTBALL USE MUST BE WORN AT ALL TIMES BY THE USER OR ANY PERSON WITHIN RANGE OF THIS PAINTBALL MARKER AS WELL AS OTHERS. THIS PRODUCT IS NOT INTENDED FOR UNSUPERVISED USE BY ANY MINOR. MINORS MUST BE UNDER STRICT ADULT SUPERVISION AT ALL TIMES WHEN USING THIS PRODUCT. READ AND UNDERSTAND THE COMPLETE OWNER'S MANUAL BEFORE USE OF THIS PRODUCT.

REQUEST AUTHORIZATION FORM

This form must be included with your return. You must contact ARIAKON™ @ 1-877-427-4256 and obtain a Return Merchandise Authorization Number before sending your marker back. IF YOU DO NOT HAVE THE RETURN NUMBER WRITTEN ON THE PACKAGE IT WILL BE REFUSED!!!

CO# _____

Name _____

Address _____

Phone () _____

Product: _____

Description of Problem: _____

Most repairs are completed within 3 to 5 business days. Any costs associated with parts and/or labor that is not covered by the warranty is the sole responsibility of the customer. Customers will be contacted prior to out of warranty repairs. **Out of warranty repairs will be charged at a rate of \$15 hour + the cost of parts.** Return shipping is not covered for out of warranty items and will be the responsibility of the customer. Items must be picked up or shipped out within 30 days of completion of repairs. If the customer does not pickup merchandise or cover shipping and handling charges for return of such products, the customer agrees to relinquish all rights and titles to and waives all claims against ARIAKON™ for credit related to such products. **This form must be filled out and signed by an Adult over the age of 18.**

Signature _____

ARIAKON SIM-5, SIM-5N .68 CALIBER PAINTBALL MARKER

WARRANTY INFORMATION

LIMITED 90 DAY WARRANTY

ARI AKON™ products are warranted for 90 Days from the original date of retail purchase. During the warranty period, any part, because of manufacturing defects or workmanship, that fails to function properly under normal use shall be repaired or replaced, at ARI AKON'S™ sole discretion, free of charge. This product must be operated in accordance with the instructions included with the unit.

WHAT IS COVERED

Any parts which are determined to be defective. Labor associated with the warranty repairs. Transportation charges to consumer for repaired product.

WHAT IS NOT COVERED

Malfunctions or damage resulting from misuse, failure to perform normal maintenance (see pages 9, 16-23), tampering, unauthorized repairs, modifications, alterations, abuse, neglect, accident, aftermarket parts and add-ons. Wearable part such as, but not limited to, anodizing, o-rings, cup seal, ball detent, sights, springs, screws, plastic parts, and plastic finishes. Transportation charges to ARI AKON™ for defective product. Use of Loctite® or non-approved lubricant on any ARI AKON™ product will void warranty.

WARRANTY CLAIMS

USA customers: You must contact ARI AKON™ @ 1-877-427-4256 and obtain a Return Merchandise Authorization Number. The Repair Authorization Form (see page 27), filled out, and a copy of Original Purchase Receipt must be included with the return. Package the unit carefully using ample padding material to prevent damage in transit and ship it prepaid and insured. We recommend that you ship your return product using a method of shipment that supplies proof of delivery to establish liability.

ARI AKON™ is not responsible for items that do not reach us or are lost / damaged in transit.

Please return to:

ARI AKON™

2794 Loker Ave West, Suite #107

Carlsbad CA USA 92008.

RMA#

International Customers: Please return product to your nearest distributor. If you do not know your distributor, please call 1-877-427-4256 and ask for our International Department for assistance.

IMPLIED WARRANTIES:

WE MAKE NO EXPRESS WARRANTIES EXCEPT THOSE STATED IN THIS SECTION. ARI AKON™ MAKES NO REPRESENTATIONS OR WARRANTIES, EITHER EXPRESS OR IMPLIED, OF ANY KIND WITH RESPECT TO PRODUCTS SOLD, INCLUDING BUT NOT LIMITED TO QUALITY, MERCHANTABILITY AND FITNESS FOR A PARTICULAR PURPOSE. YOU AGREE THAT THE SOLE AND EXCLUSIVE MAXIMUM LIABILITY, TO ARI AKON™ ARISING FROM ANY PRODUCT SOLD, SHALL BE THE PRICE OF THE PRODUCT ORDERED. WE RESERVE THE RIGHT TO MODIFY THIS WARRANTY AT ANY TIME AT OUR SOLE DISCRETION. SOME STATES DO NOT ALLOW LIMITATIONS ON HOW LONG AN IMPLIED WARRANTY LASTS, SO THE ABOVE LIMITATIONS MAY NOT APPLY TO YOU. TO THE EXTENT ANY PROVISIONS OF WARRANTY IS PROHIBITED BY FEDERAL, STATE, OR MUNICIPAL LAW WHICH CANNOT BE PREEMPTED, SHALL NOT BE APPLICABLE. THIS WARRANTY GIVES YOU SPECIFIC LEGAL RIGHTS, AND YOU MAY ALSO HAVE OTHER RIGHTS WHICH VARY FROM STATE TO STATE AND COUNTRY TO COUNTRY.

LIABILITY STATEMENT:

ARI AKON™ SHALL NOT BE LIABLE, UNDER ANY CIRCUMSTANCE, FOR CONSEQUENTIAL DAMAGES, INCIDENTAL DAMAGES, OR INCIDENTAL EXPENSES, INCLUDING BUT NOT LIMITED TO, DAMAGE/LOSS OF PROPERTY, LOSS OF LIFE, PERSONAL INJURY OR ANY OTHER EXPENSE RESULTING FROM THE USE OF THIS WEAPON, INCLUDING THE INTENTIONAL, RECKLESS, NEGLIGENT OR ACCIDENTAL DISCHARGES. SOME STATES DO NOT ALLOW THE EXCLUSION OR LIMITATION OF INCIDENTAL OR CONSEQUENTIAL DAMAGES, SO THE ABOVE LIMITATION OR EXCLUSION MAY NOT APPLY TO YOU.

GOVERNING LAW

THE SALE(S) WILL BE GOVERNED BY THE LAWS OF THE STATE OF CALIFORNIA. VENUE AND JURISDICTION FOR ALL DISPUTES WILL LIE IN SAN DIEGO COUNTY, CALIFORNIA

ARIAKON SIM-5, SIM-5N .68 CALIBER PAINTBALL MARKER

TABLE OF CONTENTS

Congratulations on the purchase of your new paintball marker! As a leader in the paintball industry, we strive to provide one of the best markers currently in the market. This manual will provide for you the proper maintenance, instructions, and troubleshooting you will need to enjoy endless play in the game and not the sidelines. Please take the time to read and understand the parts, operations, functionality and safety precautions of this marker before attempting to load or fire.

Warnings and Liability Statement.....	4
Be Responsible! Be Safe.....	4-5
Specifications and Performance.....	6
Getting Started.....	6-7
Unloading your Marker.....	8
Cleaning and Maintenance.....	9
Storage and Transporting your marker.....	10
Loading your Marker.....	11-12
Upgrades.....	13
Schematic.....	14-15
Disassembly Diagrams.....	16-22
Diagram 1-1 Stock removal.....	16
Diagram 1-2 Sight rail removal.....	16-17
Diagram 1-3 Barrel removal.....	17
Diagram 1-4 Removing Marker internals.....	17-18
Diagram 1-5 Removing the Trigger assembly..	19
Diagram 1-6 Removing the ASA.....	19-20
Diagram 1-7 Removing the Cup Seal.....	20
Diagram 1-8 Removing the Feed.....	21
Diagram 1-9 Removing the Hand Guard.....	21
Diagram 1-10 Removing the Front Sight.....	21
Diagram 1-11 Removing the Cocking Lever.....	23
Troubleshooting.....	23-25
Warranty.....	26
Repair Authorization Form (RMA).....	27

WARNING AND LIABILITY STATEMENT

This marker is classified as a dangerous weapon and is surrendered by ARI AKON™ with the express understanding that the purchaser assumes all liability resulting from unsafe handling, misuse, or any action that constitutes a violation of any applicable laws or regulations. ARI AKON™ Assumes no liability for, and shall not be liable for personal injury, loss of property or life resulting from use of this weapon under any circumstances, including but not limited to those resulting from intentional, reckless, negligent, or any other possible accidental discharges.

All information contained in this manual is subject to change without notice. ARI AKON™ Reserves the right to make changes and improvements to products without incurring any obligation to incorporate such improvements in products previously sold.

BE RESPONSIBLE! BE SAFE!

The ownership and use of this marker places the total responsibility of its safe and lawful use upon you. You must observe the same safety precautions as you would any firearm to assure the safety not only yourself, but everyone around you. The user, at all times, must use caution when using this marker.

- Do not pressurize, load, or fire this marker until you have completely read and understood this manual and are familiar with its operation and safety procedures.
- Handle this marker as if it were loaded at all times.
- Wear paintball approved goggles and full face mask when you are firing your marker, or are within range of anyone else firing their marker. NEVER shoot at someone who is not protected with gear as described.
- Always leave the marker in 'SAFE' mode when not actually in game play.
- Do not carry this paintball marker in public unless it is stored in a paintball case or bag.

TROUBLESHOOTING CONTINUED

Firing	Paintballs only shoot a few feet out of the barrel	Make sure the internal have been reassembled correctly.
		Clean bolt and striker making sure they are free of debris or broken paint
		Inspect the bolt (<i>part #26</i>) and striker (<i>part #34</i>) o-rings and make sure that they are well oiled and fit snugly. Replace if necessary
		Make sure the bolt (<i>part #26</i>) has not been placed upside down.
	Paintballs roll out of the barrel when I point my marker downward.	Make sure the ball detent (<i>part #22</i>) is installed properly, not worn out, and that the screws (<i>part #24</i>) are not over tightened. Replace if necessary
		Make sure the paintballs being used are the proper size. They should not roll freely out of the barrel when it is pointed downward
Breaking paint	Make sure you are using high quality paintballs that are not old, dirty or are misshaped.	
	Clean barrel and breech area of broken paint and debris	
	Make sure ball detent (<i>part #22</i>) is not worn. Replace if necessary. Note: Screws holding ball detent (<i>part #24</i>) should not be over-tightened	

ARIAKON SIM-5, SIM-5N .68 CALIBER PAINTBALL MARKER

TROUBLESHOOTING CONTINUED

Firing	The marker will not cock	Make sure the connector pin (<i>part #27</i>) is properly installed in the bolt and striker. See diagram 1-4 on page 18.
	Marker does not fire	Make sure air source is inserted properly.
		Make sure marker has been re-assembled properly
		Make sure paintballs are being allowed into the marker
		Make sure the Bolt (<i>part #26</i>) was not inserted upside down. Both holes on the bolt must point downward.
		Make sure that your marker is not in 'SAFE' mode.
	Marker sputters or doesn't re-cock	Check to make sure the air tank is full
		Clean bolt and striker making sure they are free of debris or broken paint
		Inspect the bolt (<i>part #26</i>) and striker (<i>part #34</i>) o-rings and make sure that they are well oiled and fit snugly. Replace if necessary
	Paintballs Curve	Make sure you are using high quality paintballs that are not old or dirty
		Clean barrel and breech area of broken paint and debris
	More than one paintball comes out at a time	Make sure the ball detent (<i>part #22</i>) is installed properly, not worn out, and that the screws (<i>part #24</i>) are not over tightened. Replace if necessary
Make sure the paintballs being used are the proper size. They should not roll freely out of the barrel when it is pointed downward		

ARIAKON SIM-5, SIM-5N .68 CALIBER PAINTBALL MARKER

BE RESPONSIBLE! BE SAFE! CONTINUED

- Always make sure your barrel is properly covered with a barrel plug or cover whenever you are not actually in game play.
- Only pressurize and load the marker when you intend to immediately use it. Always unload and remove CO₂ cylinder immediately after use for safe storage.
- Never point the marker at anything you do not intend to shoot.
- Only use paintball markers where it is legal and/or approved.
- Always keep the muzzle pointed down or in a safe direction.
- Use only .68 caliber paintballs. Never load or attempt to fire any other objects.
- Wear proper attire and avoid exposing any skin when playing the game of paintball.
- Keep exposed skin away from escaping CO₂ gas when installing or removing the cylinder.
- Never look directly into the barrel while it is attached to the marker. Accidental discharge into the eyes may cause permanent injury or death.
- Avoid shooting an opponent at point blank (6 feet or less).
- Never disassemble or perform maintenance to the marker while it is pressurized with gas.
- Never shoot at wildlife or any other animals.
- Never shoot your marker at personal property of others.

SPECIFICATIONS

Model..... SIM-5™

Caliber..... .68 caliber

Action..... Semi-automatic
(open bolt blow-back)

Power.....CO₂, Compressed air, or Nitrogen

Barrel length..... 12 inches

Overall Length..... 29 inches

Weight (without tank or hopper).... 4.14 lbs

PERFORMANCE

Operating a paintball marker below 70°F (21°C) will decrease the number of effective shots. The same is true for operating above 70°F (21°C). Many factors affect velocity and accuracy, including brand of paintball, type of paintball, amount of CO₂ in source, lubrication, barrel condition and temperature.

Air Leak	Air leaks from where I screw in the tank	Inspect the valve on your tank to ensure that it is not damaged
		Replace the o-ring on your tank
		Check for debris in the ASA (part #35)
	Air leaks out from the barrel	Make sure your marker has been reassembled properly. Refer to "Cleaning and Maintenance" and "Disassembly" beginning on pages 9,16-23
		Replace the cup seal (part #17)
		Replace the o-rings on the valve (part #19)
Air leaks from between the vertical ASA (part #35) and the body	Replace the valve (part #19)	
	Make sure the plastic piece (shown on page 20) is not missing	
Velocity	Velocity is too high	Turn the velocity adjustment screw (part #29) out/counter-clockwise until desired velocity is reached
		If the velocity spring (part #32) is new it may need to be broken in; until you are able to achieve the desired velocity
	Velocity is too low	Turn the velocity adjustment screw in/clockwise until desired velocity is reached
		Internal parts may be dirty or o-rings may be damaged. Refer to "Cleaning and Maintenance" on page (9)
		Check bolt (part #26) to make sure it is not installed upside down. Both holes on the bolt must face downward

DI SASSEMBLY CONTI NUED

Diagram 1-11 Cocking Lever Disassembly

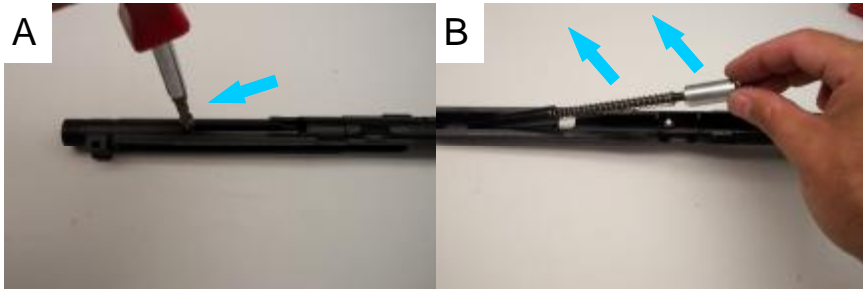

A— Begin by unscrewing the Cocking Lever Screw with a flat or '—' screwdriver. (part # 2).

**** NOTE: TAKE A CLOSE LOOK IN THE SIGHT HOUSING IN THE ORDER OF THE COCKING LEVER SPRING (part # 5), THE COCKING ROD (part # 3), AND THE COCKING ROD GUIDES (parts # 4&6) AND MAKE SURE YOU PLACE THESE BACK IN THAT SAME ORDER.****

B— Pull them out towards the direction shown.

For re-assembly on any of the previous disassemblies shown should be done in the exact reverse order of the instructions provided. For added support we are providing these video clips on our website at www.ariakon.com for you to download during anytime of need. Again, Please pay special attention to all the *****asterisks***** noted.

GETTING STARTED

IMPORTANT: Paintball approved eye and face protection must be worn at all times when handling this or any other marker. Always make sure that when not actively firing the marker in a paintball game that the marker is in 'SAFE' mode and the barrel plug or barrel cover is properly inserted.

1) Ammo Box (Hopper):

Make sure that the feed port is clean to keep the paintballs feeding properly and to help avoid breaking any paint. Also, make sure there are no sharp edges or debris in your hopper. Install the hopper into the feed. Now open the lid on the hopper and fill with paintballs.

2) Air Source Installation:

First make sure the marker is in 'SAFE' mode. Next you need to cock the marker by pulling the Cocking lever (*part# 2*) all the way back until it clicks. To install the air source, insert the tank valve end into the Air source adapter (*part# 34*). Twist the tank clockwise into the marker until you hear and feel the tank 'engage', then give the tank about 1/3 turn more so it does not become loose. Your marker is ready to fire once you switch it from 'SAFE' mode to fire mode.

3) Adjusting the Velocity:

To adjust the velocity, use the velocity adjustment screw (*part # 29*) on the rear of the marker directly under the bolt. Turning the adjustor in or clockwise will increase the velocity, and adjusting it out or counter-clockwise will lower the velocity.

UNLOADING YOUR MARKER

IMPORTANT: Paintball approved eye and face protection must be worn at all times when handling this or any other marker. Always make sure that when not actively firing the marker in a paintball game that the marker is in 'SAFE' mode and the barrel plug or barrel cover is properly inserted.

CAUTION: WHEN REMOVING YOUR AIR SOURCE MAKE SURE THE BRASS OR NICKEL PLATED VALVE IS SECURELY ATTACHED TO THE CANISTER, ROTATES WITH THE CANISTER, AND DOES NOT UNSCREW FROM THE CANISTER. THE CANISTER SHOULD UNSCREW FROM THE PAINTBALL MARKER IN ABOUT THREE OR FOUR FULL TURNS; IF YOU FINISH THE FOURTH FULL TURN AND THE CANISTER IS NOT UNSCREWED FROM THE PAINTBALL MARKER, **STOP**. TAKE IT TO A PROFESSIONAL. ANY FILLING, MODIFICATIONS, OR REPAIR TO YOUR CANISTER SHOULD BE PERFORMED BY A TRAINED PROFESSIONAL.

- 1) First make sure your marker is set in 'SAFE' mode and your barrel cover, or plug, is properly installed.
- 2) To unload your marker remove the ammo box completely or empty it so it is free of paintballs. Then point the marker in a safe direction, remove the barrel cover, take the marker out of 'SAFE' mode and fire several times to be sure there are no paintballs lodged in the chamber, then immediately return the marker to 'SAFE' mode and replace the barrel cover.
- 3) To remove a charged air source turn the cylinder approximately $\frac{3}{4}$ of a turn counterclockwise. This allows the tank pin valve to close so that no CO₂ will enter the marker. With the barrel plug, or cover, properly installed point the marker in a safe direction and discharge the remaining CO₂ in the marker by pulling the trigger until the marker stops firing. (This may take 5-6 shots). Make sure to return your marker to safe mode when finished discharging any remaining CO₂.

NOTE: If your marker continues to fire after you have turned the tank then the pin valve has not closed yet and you may need to unscrew the tank a little further. If you turn the tank $\frac{3}{4}$ of a turn and it begins to leak before you pull the trigger then you have turned it too far and you may have damaged the tank o-ring.

DI SASSEMBLY CONTI NUED

Diagram 1-8 Removing the Feed

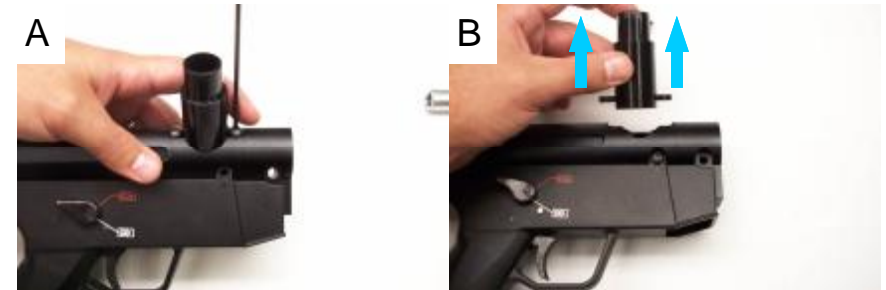

A— Begin by removing the 2 Feed Screws (parts # 11) with a 3mm Hex tool.

B— Pull the Feed (part # 10) towards the direction shown.

Diagram 1-9 Removing the Hand Guard

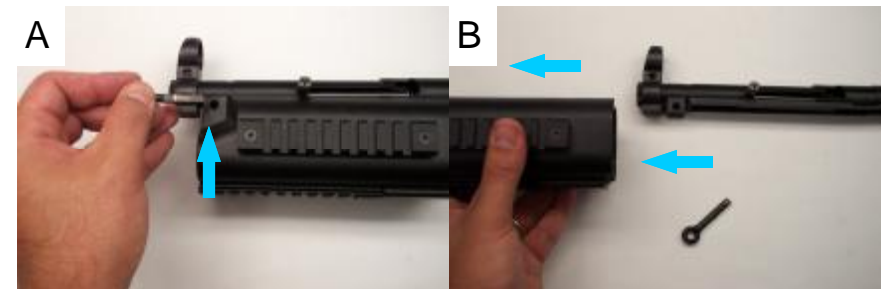

A— Begin by pulling the Front Hand Guard Retaining Pin (part #38) out.

B— Pull the Front Hand Guard (part #37) towards the direction shown.

Diagram 1-10 Removing the Front Sight

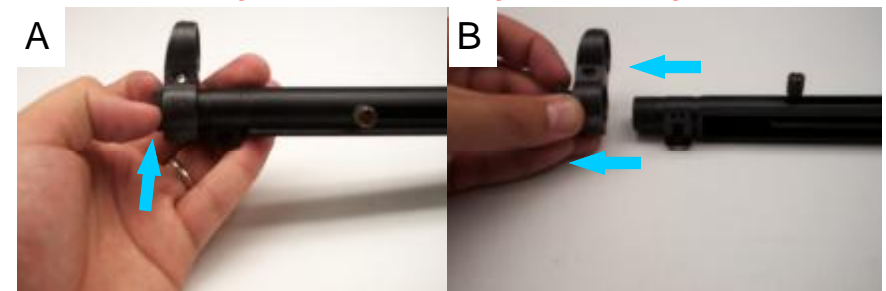

A— Begin by removing the Front Sight Retaining Lug (part #44)

B— Remove both the Front Sight Retaining Lug and Front Sight (parts # 43 and 44)

DI SASSEMBLY CONTI NUED

Diagram 1-6 Removing the ASA cont...

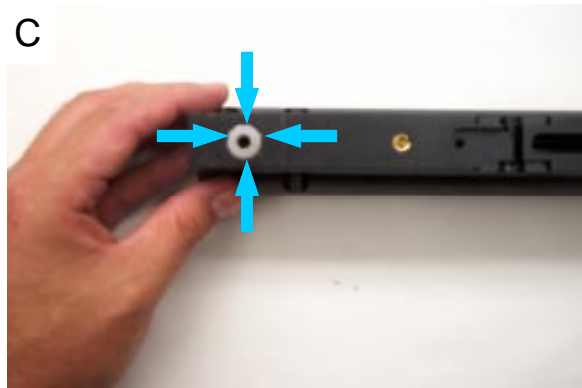

C— DO NOT LOSE THIS PIECE YOUR MARKER WILL LEAK GAS IF THIS PIECE IS MISSING.

Diagram 1-7 Removing the Cup seal

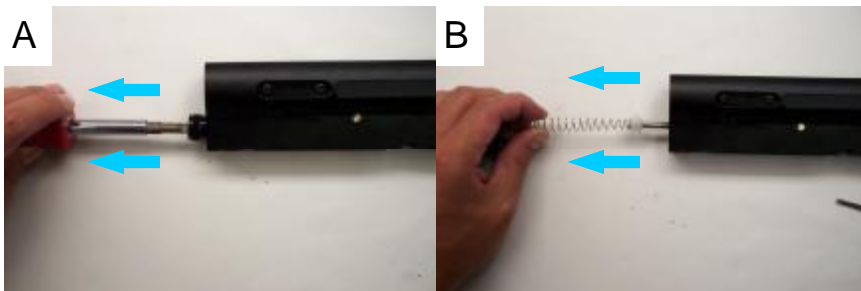

A— Begin by unscrewing the Volume Chamber Lug (part # 15) with a Flat or '—' screwdriver and remove towards direction shown.

B— Pull out both the Cup Seal Return Spring (part # 16) and the Cup Seal (part # 17)

CLEANING AND MAINTENANCE

Normal maintenance and cleaning will reduce the majority of any possible complications with the performance of your marker. For best results we recommend cleaning your marker after every use and replacing the o-rings after every other use. Use a damp towel to wipe off paint, oil and any debris. Do Not use any cleaning solvents such as 409® or Simple Green®. Use of such products on your marker may cause corrosion and/or damage the internal parts, and WILL void your warranty. When oiling the cleaned parts we recommend using any paintball brand paintball gun oil. Use of other lubricants such as WD-40®, graphite, and oil designed for actual firearms may cause build up and/or damage the internal parts or seals. Use of such products WILL void your warranty. In order to help you maintain your marker, We have provided these following 11 steps.

WARNING: Before conducting any maintenance, remove the air source from your marker (Refer to 'Unloading Your Marker'). Make sure your marker is in 'SAFE' mode and your barrel has either a cover or plug inserted.

- 1) Remove the stock by loosening and removing the retaining screw (part #45), then pulling the stock straight out from the rear of the body.
- 2) Next unscrew the mid and rear retaining screw (part #'s 8 and 9) then remove the front hand guard pin (part #38) by pulling outward.
- 3) Slide the sight rail (part #1) and hand guard (part #37) towards the front of the barrel while carefully lifting the back end of the sight rail exposing the top portion of the connector pin (part #27).
- 4) Remove the velocity adjustment screw (part #29) with a hex wrench by turning it counter clockwise.
- 5) Next, remove the velocity lug (part #30) using a flathead screwdriver. Use caution when removing, parts are under pressure from the velocity spring.
- 6) Then, remove the guide pin (part #31), velocity spring (part #32) and striker cushion (part #33)
- 7) Next, loosen the connector pin retaining screw (part #28), by turning it counter-clockwise about two full turns. **DO NOT REMOVE THIS SCREW.**
- 8) Remove the connector pin (part #27), bolt (part #26), and striker (part #34). When doing so, be sure to note which direction each piece fits into the marker for reassembly.
- 9) Inspect all o-rings making sure they fit snugly and are not missing, discolored, or damaged.
- 10) Clean the removed parts by wiping them with a damp towel. Then oil all moving surfaces and all o-rings with paintball marker oil.
- 11) Reinstall the removed parts in the reverse order, making sure that the connector pin (part #27) is properly positioned so it connects the bolt (part #26) and striker (part #34). Note: When reinserting the striker you will have to press the trigger in order to allow the striker to pass the sear **ALSO NOTE: The two holes on the bolt MUST POINT DOWNWARD.**

Refer to "Disassembly" beginning on page 13.

NOTE: Basic maintenance of your ARIAKON™ marker is your responsibility. Your marker will provide you with dependable performance for many games if properly cared for. Not properly maintaining your marker WILL void your warranty.

STORING YOUR MARKER

NOTE: Proper storage of your ARI AKON™ paintball marker will help cut down on the maintenance needed when bringing the marker back out to play.

- 1) You should store your marker in a dry area. Make sure that the rear bolt, striker and spring are cleaned and oiled so that they do not rust (Refer to 'Cleaning and Maintenance'). Store your marker with the bolt in the rear position (cocked).
- 2) When removing your marker from storage you should re-oil all moving parts and o-rings before any use.
- 3) Before storing, empty and remove the CO₂ tank from the gun (Refer to 'Unloading Your Marker').

TRANSPORTING YOUR MARKER

Observe all local, state and federal laws concerning the transportation of paintball markers. For information concerning any of the laws in your area, contact your local law enforcement agency.

Never carry your marker uncased when not on a playing field. The non-playing public and law enforcement personnel cannot distinguish between a paint marking device or firearm. For your safety and to protect the image of the sport, always carry your marker in a suitable case or in the box it was purchased in. DO NOT conceal your marker under your clothing when transporting.

DI SASSEMBLY CONTI NUED

Diagram 1-5 Removing Trigger Assembly

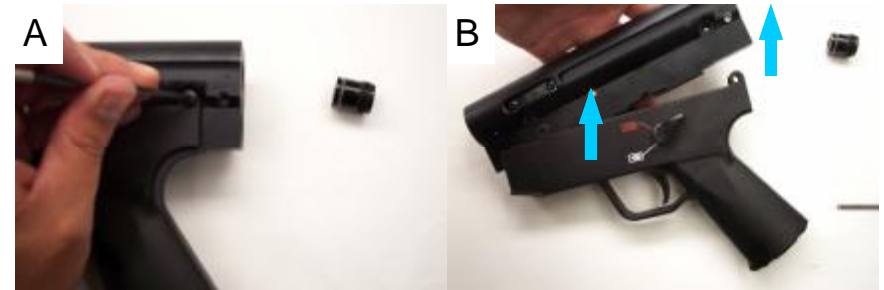

A— Begin by removing the 4 Trigger Assembly Screws (part # 40) with a 3mm Hex tool.

****NOTE: THERE ARE 2 IN FRONT AND 2 IN THE BACK ON BOTH SIDE OF THE ASSEMBLY.**

B— Pull the Main Body (part # 14) and the Trigger Assembly (part # 39) apart as shown.



C— Once the Main Body (part # 14) and the Trigger Assembly (part # 39) are apart from one another it will look as picture C. ****NOTE THE SCREW PLACEMENTS.****

Diagram 1-6 Removing the ASA

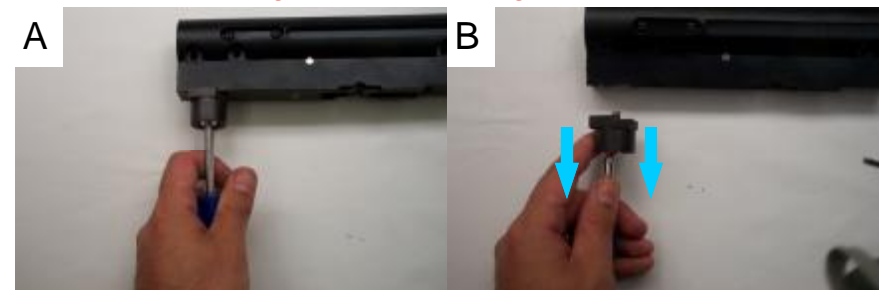

A— Begin by using a 3/8" socket and remove the ASA Pin (part # 36 Not shown)

B— Completely remove towards the direction shown.

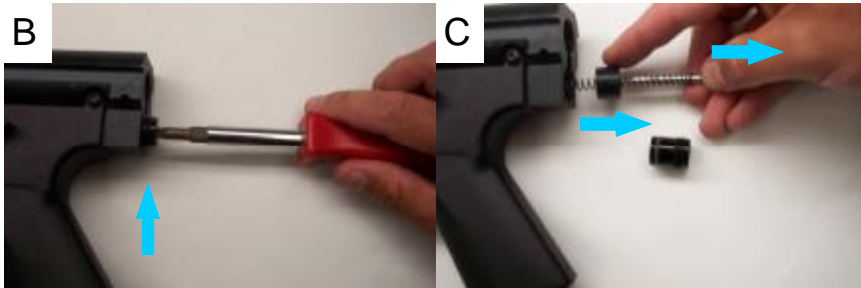
DI SASSEMBLY CONTI NUED**Diagram 1-4 Removing Marker Internals Continued...**

B— Unscrew and Remove the Velocity Lug (part # 30) With a Flat or '—' Screw driver

C— Pull out the Spring Guide Pin (part # 31), the Velocity Spring (part # 32), and the Striker Cushion (part # 33) towards the direction shown.

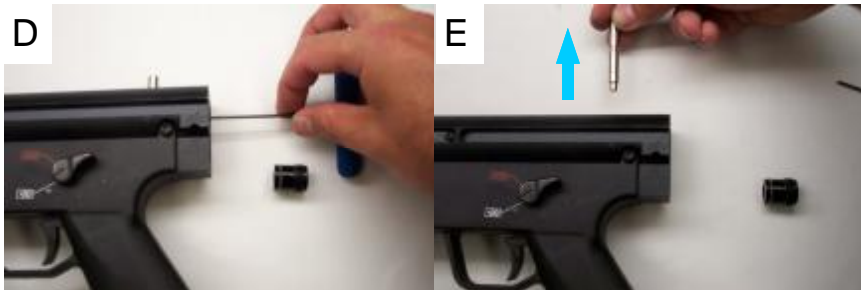

D— Unscrew the Connector Pin Retaining Screw (part # 28) on the back end of the bolt (part # 26) 3 turns with a 2mm Hex tool.

****NOTE: DO NOT REMOVE THIS SCREW****

E— Remove Connector Pin (part # 27) towards the direction shown.



F— Tilt upward and shake out both the bolt and striker (parts # 26 and 34) ****NOTE: YOU MAY HAVE TO PUSH OUT THE STRIKER USING A SCREWDRIVER OVER THE TRIGGER ASSEMBLY.****

LAODING YOUR MARKER

These are the basic steps in loading your marker correctly and safely. Please follow the order of these directions every time you should use this marker.

STEP 1: Loading your marker with a hopper.

****Make certain that your maker is in the 'SAFE' position.****

Start off by placing a elbow on your hopper. Shown on picture 'A'



STEP 2: After the elbow has been placed on the hopper secure it to the marker feed (part# 10) Also shown in picture 'A'

Step 3: Loading your marker with your air source. Start off by cocking you maker in the 'LOAD' or 'COCKED' position as shown on picture 'A'



Take the cocking lever (part # 2) and slide back towards the direction shown till you feel and hear a 'CLICK'

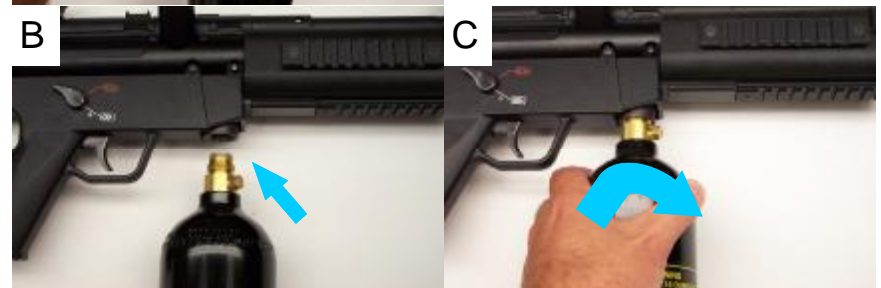

STEP 4: Place the tip of the air canister in the ASA or Air Source Adapter (part# 35) and turn in a Clockwise fashion to screw the canister in place as shown on picture 'C'. Once you feel the marker engage, turn the canister clockwise 1/3 more to ensure that it will not become loose.

ARIAKON SIM-5, SIM-5N .68 CALIBER PAINTBALL MARKER

LOADING YOUR MARKER CONTINUED

STEP 5: Loading your marker with Paint Balls.
Start off by opening the back end of your hopper.

****LOOK INSIDE YOUR HOPPER TO ENSURE NO DEBRIS OR OTHER THINGS ARE INSIDE BEFORE YOU LOAD THE PAINT.****



STEP 6: Load the hopper with paint balls as shown in picture 'B'.
**** Use of high quality paint balls are always recommended to ensure accuracy and less problems with breaking paint.****
STEP 7: Close the lid as shown in picture 'C'

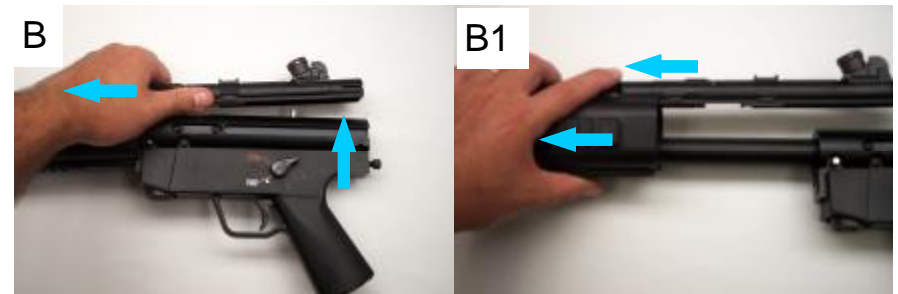

ARIAKON SIM-5, SIM-5N .68 CALIBER PAINTBALL MARKER

DISASSEMBLY CONTINUED**Diagram 1-2 Sight Housing Removal cont...**

B and B1— Gently pull the whole Sight Rail (part # 1) while lifting the back end over the connector pin (part # 27) towards the direction shown.

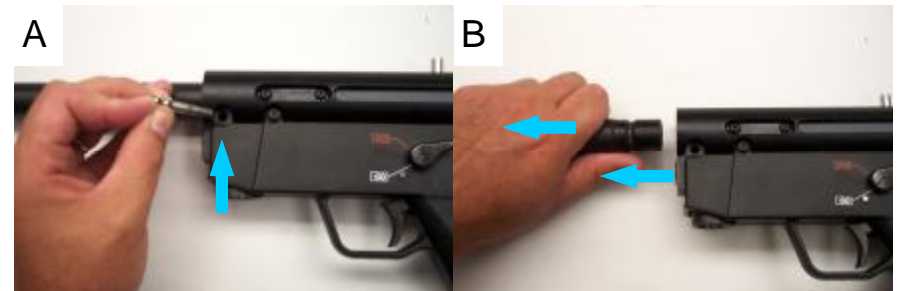
Diagram 1-3 Barrel Removal

A— Pull the Barrel Retaining Pin (part # 13) out.
B— After pin has been removed pull the barrel towards the direction shown. ****NOTE: BARREL DOES NOT UNSCREW****

Diagram 1-4 Removing Marker Internals

A—Begin by unscrewing the Velocity Adjustor Screw (part # 29)

DI SASSEMBLY

This section will guide through the disassembly of your marker. Take note that we are also providing step-by-step instructions on our website at www.ariakon.com Please visit our site and download the disassembly clips if you are not able to comprehend the instructions and need an added visual aide.

Diagram 1-1 Stock Removal

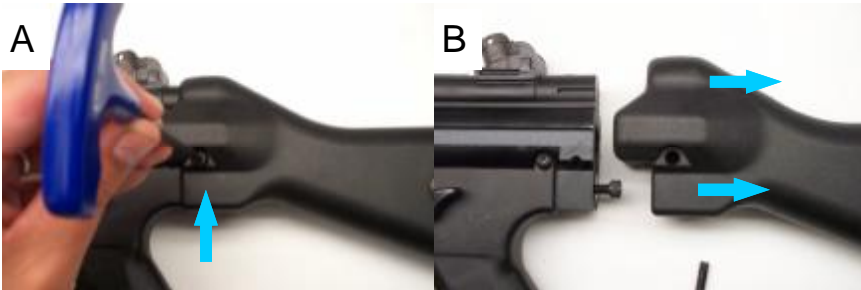

A— loosen stock retaining screw. B— Pull stock towards direction (part # 45) With a 4mm Hex tool shown.

Diagram 1-2 Sight Housing Removal

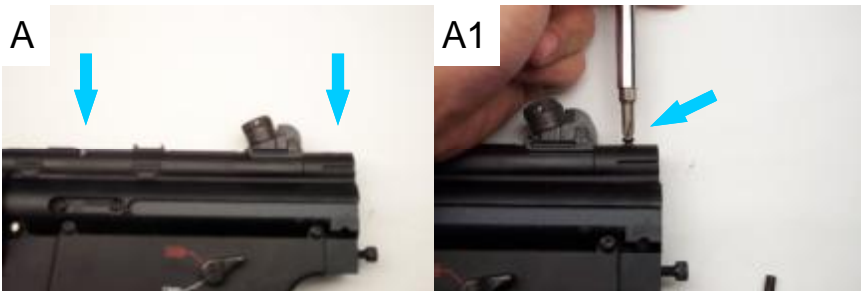

A and A1— Loosen both mid and rear retaining (parts # 8&9) screw with a Phillips or '+' screwdriver.

ACESSORIES AND UPGRADES

It is now become easier than ever to upgrade your quality marker to a intimidation machine. Don't be the one giving your opponents the upper hand in scare tactics. Dominate the playing field and you opponents with these add on accessories.

Accessories	Quantity	Price	Total Price
			(Quantity x Price)
Laser Sight Kit		\$79.99	
TAC Light Kit		\$37.99	
Deluxe TAC Light Kit		\$79.99	
Remote System		\$49.99	
Barrel Extension		\$79.99	
Vertical R.I.S. Grip		\$29.99	
R.I.S Low Profile Rail Guards- Black		\$32.99	
R.I.S. Replacement Panel- Green		\$4.99 Each	
Parts Kit		Coming soon	
Deluxe Parts Kit		Coming soon	

SIM-5 PARTS LIST

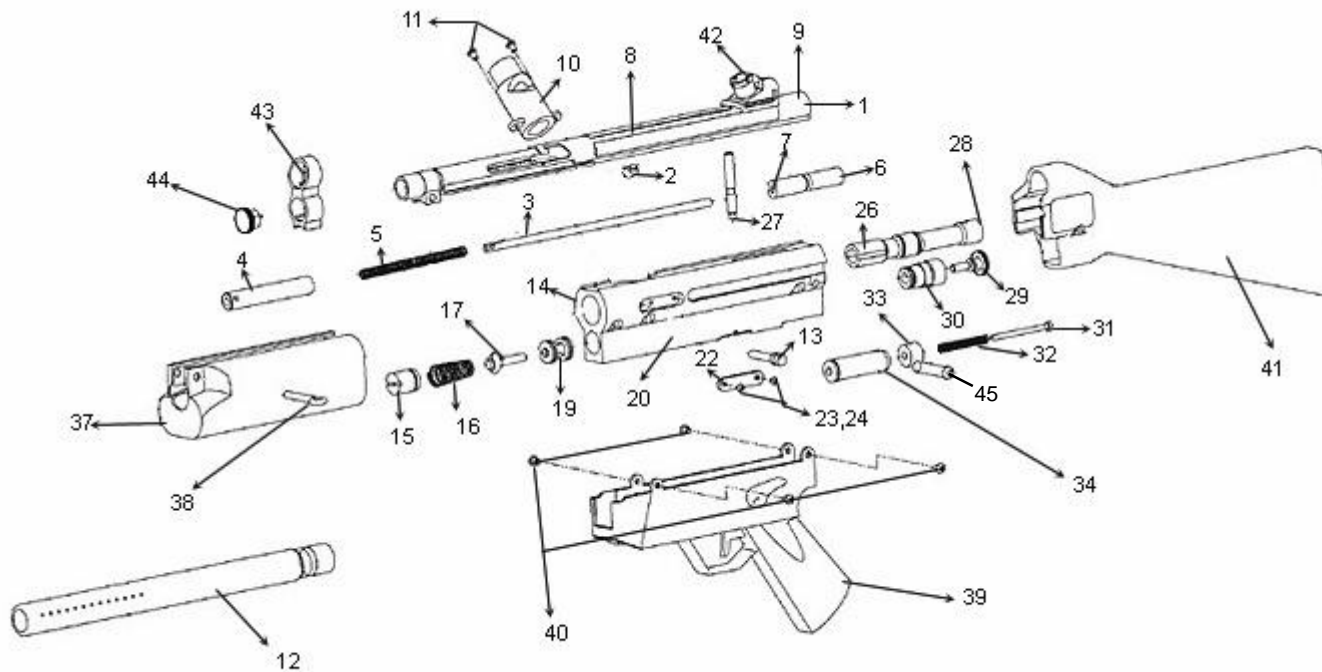

1. SIGHT RAIL
2. COCKING LEVER
3. COCKING ROD
4. FRONT COCKING ROD GUIDE
5. COCKING LEVER SPRING
6. REAR COCKING ROD GUIDE
7. SPACING WASHER
8. MID RETAINING SCREW
9. REAR RETAINING SCREW
10. FEED
11. FEED RETAINING SCREW (2)
12. BARREL
13. BARREL RETAINING PIN
14. MAIN BODY
15. VOLUME CHAMBER LUG
16. CUP SEAL RETURN SPRING
17. CUP SEAL
18. STANDARD O-RINGS (7- Bolt, Striker, Velocity Lug, Valve, Volume Chamber Lug)
19. VALVE
20. VALVE RETAINING PIN (Not Shown)
21. VALVE RETAINING SCREW (Not Shown)
22. BALL DETENT
23. BALL DETENT WASHERS (2)
24. BALL DETENT SCREW (2)
25. PLASTIC AIR SEAL (Not Shown)
26. BOLT
27. CONNECTOR PIN
28. CONNECTOR PIN RETAINING SCREW
29. VELOCITY ADJUSTMENT SCREW
30. VELOCITY LUG
31. SPRING GUIDE PIN
32. VELOCITY SPRING
33. STRIKER CUSHION
34. STRIKER
35. ASA (Not Shown)
36. ASA PIN (Not Shown)
37. FRONT HAND GUARD
38. FRONT HAND GUARD RETAINING PIN
39. TRIGGER ASSEMBLY
40. TRIGGER ASSEMBLY SCREWS (4)
41. STOCK
42. REAR SIGHT
43. FRONT SIGHT
44. FRONT SIGHT RETAINING LUG
45. STOCK RETAINING SCREW